

EN25-II · EW25-II拖链-安装尺寸及技术参数

EN25-II · EW25-II Cable Chain-Installation Dimensions and Technical Parameters

架空长度 Unsupported length

- L_G = 直线架空长度
- L_A = 安全塌腰架空长度
- L_G = Unsupported with straight upper run
- L_A = Unsupported with permitted sag

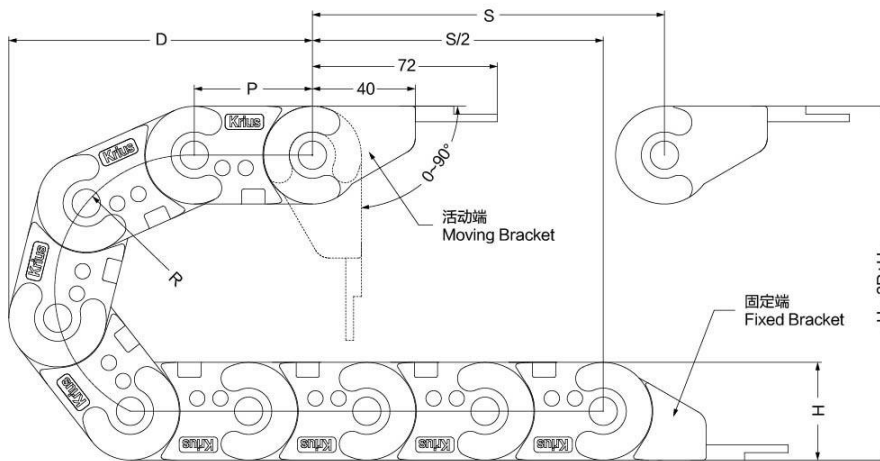
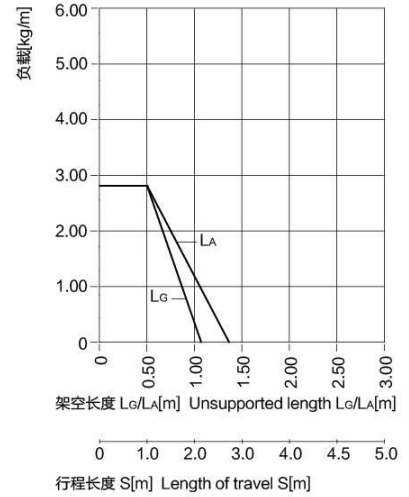
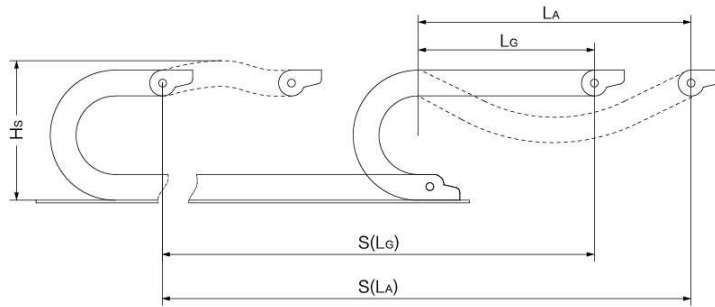

- S = 行程长度
- R = 弯曲半径
- P = 节距
- L = 拖链长度
- N = 每米链节数
- H_L = 理论安装高度
- H_s = 实际安装高度
- D = 拖链退回极限位置时的最小距离
- $K = \pi \cdot R + 2P$
- * K值可在科瑞斯相关表格中直接查询
- S = Length of travel
- R = Bending Radius
- P = Pitch
- L = Length of chain
- N = Links per meter
- H_L = Nominal clearance height
- H_s = Required clearance height
- D = Overlength Energy Chain radius in final position
- $K = \pi \cdot R + 2P$
- * You can find it from below chart for more details

R	H _L	D	K	P
55 (2.17)	148 (5.83)	120 (4.72)	265 (10.42)	46 (1.81)
75 (2.95)	188 (7.40)	160 (6.30)	330 (12.99)	46 (1.81)
100 (3.94)	238 (9.37)	210 (8.27)	405 (15.94)	46 (1.81)
125 (4.92)	288 (11.34)	260 (10.24)	485 (19.09)	46 (1.81)
150 (5.91)	338 (13.31)	310 (12.20)	565 (22.24)	46 (1.81)
200 (7.87)	438 (17.24)	410 (16.14)	720 (28.36)	46 (1.81)

实际安装高度: $H_s = H_L + 35\text{mm}$
拖链长度: $L = S/2 + K$
每米链节数: $N = 22$ (1012mm)

The required clearance height: $H_s = H_L + 1.38\text{in.}$
Chain length: $L = S/2 + K$
Links per meter: $N = 22$ (39.84 in.)

技术参数 Technical Parameters		
速度/加速度 L_G	Speed/acceleration L_G	max.25[m/s]/max.205[m/s ²]
速度/加速度 L_A	Speed/acceleration L_A	max.5[m/s]/max.8[m/s ²]
滑行速度/加速度	Gliding speed/acceleration	max.5[m/s]/max.12[m/s ²]
材料-允许温度 °C	Material-permitted temperature	igumid G/-40°C至+125°C
阻燃等级, igumid G	Flammability Class, igumid G	VDE 0304 IIC UL94 V2

EN25-II · EW25-II 拖链-产品规格范围 EN25-II · EW25-II Cable Chain-Product specifications

EN25-II · EW25-II拖链-内外可打开 EN25-II · EW25-II Cable Chain-Inner and outer can be opened

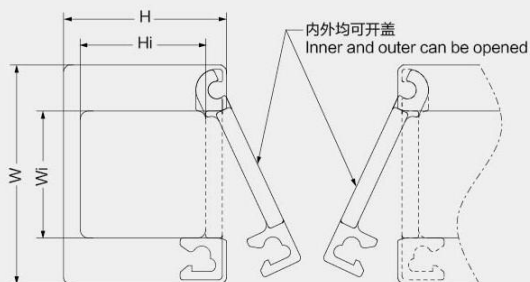

产品代码结构
Part Number Structure

EN2525-II*R*L*n

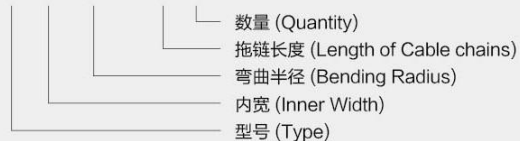

注：拖链在内侧打开（EN25-II系列）和在外侧打开（EW25-II）
为两款拖链，订购时请注明
EN25-II and EW25-II are different item, please note when order

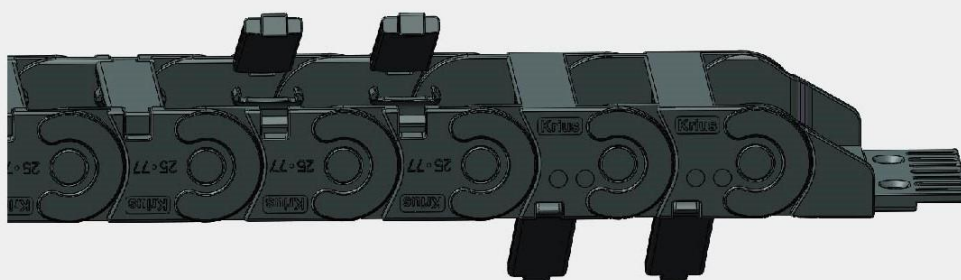

型号 Type	弯曲半径<R> Bending radius	内高<Hi> Inner height	内宽<Wi> Inner width	外高<H> Outer height	外宽<W> Outer Width	重量<G> Weight	备注 Remark
	mm (in.)	mm (in.)	mm (in.)	mm (in.)	mm (in.)	kg/m (lbs/ft)	
EN2525-II EW2525-II			25.3 (1.00)		42.7 (1.68)	0.84 (0.57)	
EN2538-II EW2538-II			38.3 (1.51)		55.7 (2.19)	0.91 (0.62)	
EN2550-II EW2550-II		25.4 (1.00)	50.3 (1.98)	38 (1.50)	67.7 (2.67)	0.95 (0.65)	
EN2557-II EW2557-II			57.3 (2.26)		74.7 (2.94)	1.00 (0.68)	
EN2577-II EW2577-II			77.3 (3.04)		94.7 (3.73)	1.17 (0.80)	

订货范例
Order details

EN2525-II * R55 * 1000mm * 2

R	Hi	D	K	P
55 (2.17)	148 (5.83)	120 (4.72)	265 (10.42)	46 (1.81)
75 (2.95)	188 (7.40)	160 (6.30)	330 (12.99)	46 (1.81)
100 (3.94)	238 (9.37)	210 (8.27)	405 (15.94)	46 (1.81)
125 (4.92)	288 (11.34)	260 (10.24)	485 (19.09)	46 (1.81)
150 (5.91)	338 (13.31)	310 (12.20)	565 (22.24)	46 (1.81)
200 (7.87)	438 (17.24)	410 (16.14)	720 (28.36)	46 (1.81)

EN25-II · EW25-II 拖链-拖链接头 EN25-II · EW25-II Cable Chain-Mounting Bracket

塑料接头，整体式 Plastic Mounting Bracket, Integrated type

- 整体式接头
- 耐腐蚀 & 耐摩擦
- 可提供预装配形式
- 可实现内外连接
- Integrated type Mounting Bracket
- Anti-corrosion, Rub-resistance
- Available preassembly form
- Can realize the internal and external connections

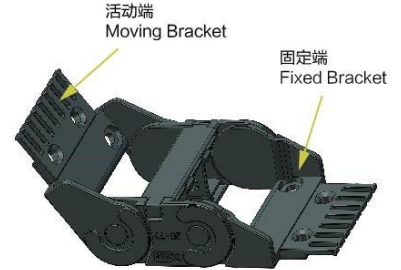

可选配的接头安装方式 Available installation methods

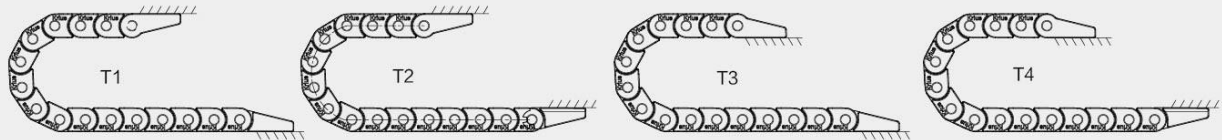

固定端
Fixed Bracket

活动端
Moving Bracket

固定端
Fixed Bracket

活动端
Moving Bracket

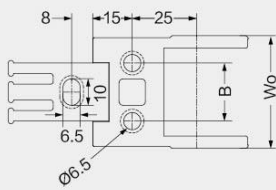

EN2525-II/EW2525-II
EN2538-II/EW2538-II

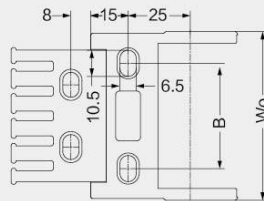
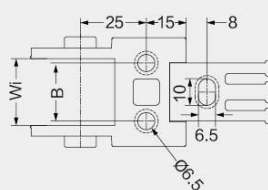

EN2550-II/EW2550-II
EN2557-II/EW2557-II
EN2577-II/EW2577-II

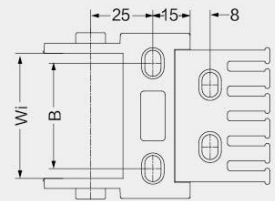

拖链型号 Type	拖链编码 Code	接头编码 Code	Wo尺寸 Dimension Wo	B尺寸 Dimension B
EN2525-II	EW2525-II	13106	42.7 (1.68)	22 (0.87)
EN2538-II	EW2538-II	13108	55.7 (2.19)	35.2 (1.39)
EN2550-II	EW2550-II	13110	67.7 (2.67)	42.3 (1.67)
EN2557-II	EW2557-II	13112	74.7 (2.94)	47.8 (1.88)
EN2577-II	EW2577-II	13114	94.7 (3.73)	67.8 (2.67)

产品代码结构 Part Number Structure

EN2525-II*B*T1



- EN2525-II*B*T1*n 两端接头
On both brackets
- EN2525-II*f*T1*n 固定端接头
Fixed bracket
- EN2525-II*m*T1*n 移动端接头
Moving bracket

★ 每款拖链的接头都有所不同，订购时如有任何疑问，请及时咨询科瑞斯。
Every bracket is different, please contact us if you have any question.

EN25-II·EW25-II 拖链-梳状板 EN25-II·EW25-II Cable Chain-Tie-wrap plate

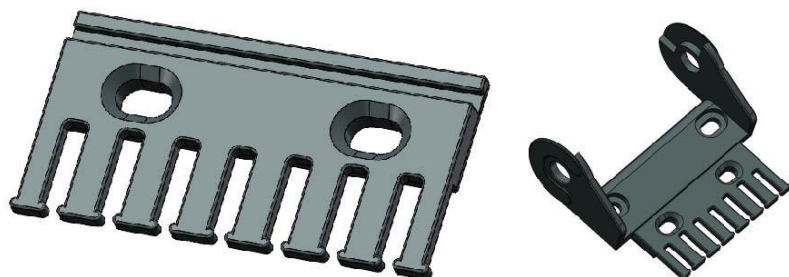

单个梳妆板
Single tie-wrap plate



组装图
Shown assembled

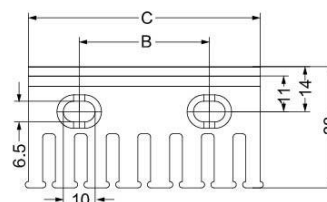
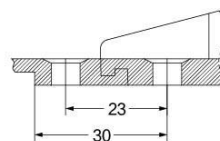

梳状板为独立部件，可根据需要进行选配
Tie-wrap is spare part independent, you can mark use or not when order

选配代码结构
Part Number Structure

EN2525-II+梳妆片 (tie-wrap plate)

内宽 (Inner Width)
型号 (Type)

型号 Type	齿数 Teeth NO.	尺寸B1 Dimension B	尺寸C Dimension C	编码 Code
EN2525-II EW2525-II	3 (0.12)	-	22 (0.87)	11031
EN2538-II EW2538-II	4 (0.16)	15 (0.59)	34 (1.34)	11031
EN2550-II EW2550-II	6 (0.24)	25 (0.89)	53 (2.09)	11032
EN2557-II EW2557-II	6 (0.24)	25 (0.89)	53 (2.09)	11032
EN2577-II EW2577-II	8 (0.31)	41 (1.61)	73 (2.87)	11032

EN25-II·EW25-II 拖链-隔离片 EN25-II·EW25-II Cable Chain-Separator

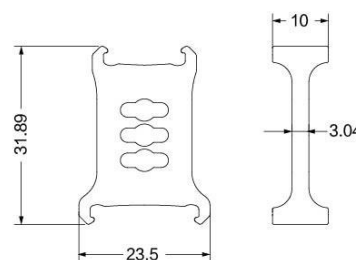
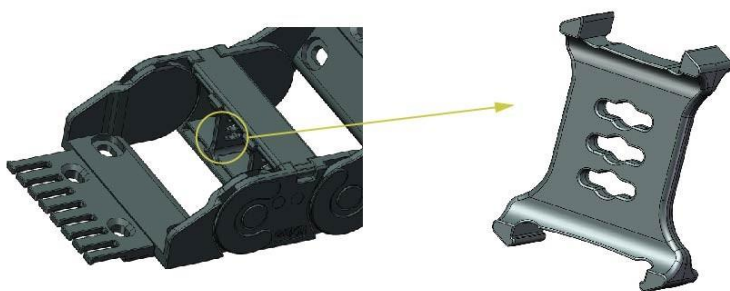

EN25-II·EW25-II拖链隔离片编码: 13120
The separator No. for EN25-II·EW25-II:13120

- 本款拖链标配隔离片为竖隔片，可以实现垂直分隔，也可订制铝杆作为横隔片，实现水平分隔
- 竖隔片的数量可以根据客户的实际需求进行配备，可以每隔一个链节装一个，也可以每隔一个链节装几个，客户可任意配备
- 竖隔片安装完成后，可以根据线缆排布进行滑动
- The standard separator is vertical direction which can make the vertical division, and also we can customize horizontal Al separator for horizontal division
- Vertical separators can be placed into each link or different quantity links, it can be customized
- Separators can be moved for different cable

