

ZQ28 拖链-安装尺寸及技术参数 ZQ28 Cable Chain-Installation Dimensions and Technical Parameters

架空长度 Unsupported length

- L_G = 直线架空长度
- L_A = 安全塌腰架空长度
- L_G = Unsupported with straight upper run
- L_A = Unsupported with permitted sag

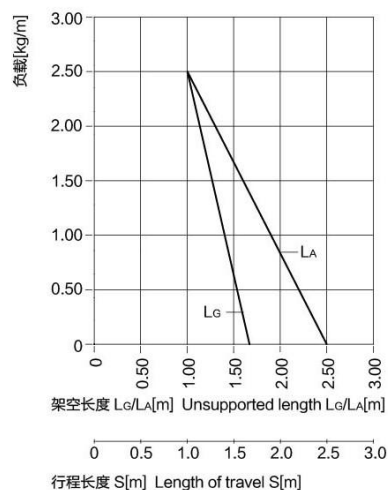
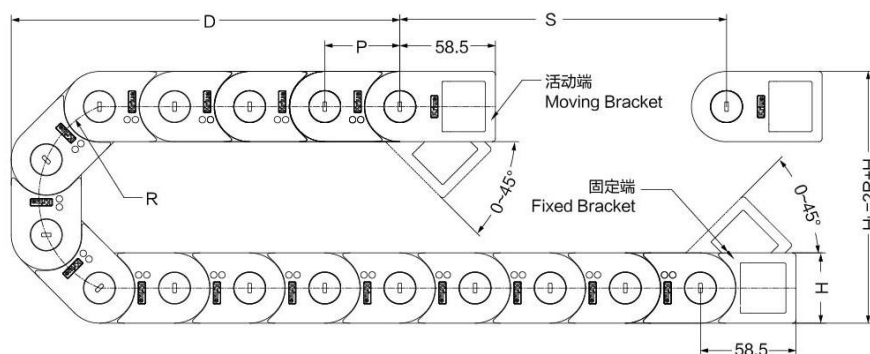
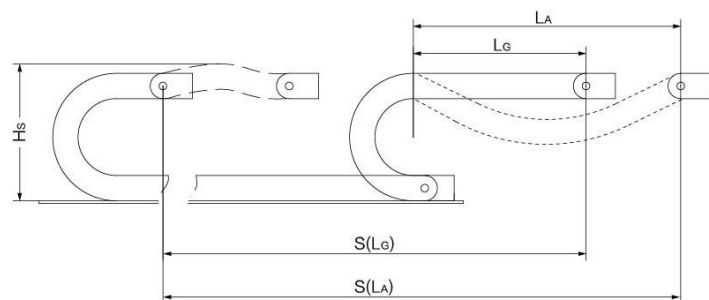

- S = 行程长度
- R = 弯曲半径
- P = 节距
- L = 拖链长度
- N = 每米链节数
- H_L = 理论安装高度
- H_s = 实际安装高度
- D = 拖链退回极限位置时的最小距离
- $K = \pi \cdot R + 2P$
- * K值可在科瑞斯相关表格中直接查询
- S = Length of travel
- R = Bending Radius
- P = Pitch
- L = Length of chain
- N = Links per meter
- H_L = Nominal clearance height
- H_s = Required clearance height
- D = Overlength Energy Chain radius in final position
- $K = \pi \cdot R + 2P$
- * You can find it from below chart for more details

R	H_L	D	K	P
55 (2.17)	153 (6.02)	120 (4.72)	265 (10.43)	46 (1.81)
63 (2.48)	169 (6.65)	136 (5.35)	290 (11.42)	46 (1.81)
75 (2.95)	193 (7.60)	160 (6.30)	330 (12.99)	46 (1.81)
100 (3.94)	243 (9.57)	210 (8.27)	405 (15.94)	46 (1.81)
125 (4.92)	293 (11.54)	260 (10.24)	485 (19.09)	46 (1.81)
150 (5.91)	343 (13.50)	310 (12.20)	565 (22.24)	46 (1.81)
175 (6.89)	393 (15.47)	360 (14.17)	640 (25.20)	46 (1.81)
200 (7.87)	443 (17.44)	410 (16.14)	720 (28.35)	46 (1.81)
250 (9.84)	543 (21.38)	510 (20.08)	880 (34.65)	46 (1.81)

实际安装高度: $H_s = H_L + 40\text{mm}$
拖链长度: $L = S/2 + K$
每米链节数: $N = 22$ (1012mm)

The required clearance height: $H_s = H_L + 1.57\text{in.}$
Chain length: $L = S/2 + K$
Links per meter: $N = 22$ (39.84 in.)

技术参数 Technical Parameters		
速度/加速度 L_G	Speed/acceleration L_G	max.25[m/s]/max.205[m/s ²]
速度/加速度 L_A	Speed/acceleration L_A	max.5[m/s]/max.8[m/s ²]
滑行速度/加速度	Gliding speed/acceleration	max.5[m/s]/max.12[m/s ²]
材料-允许温度 °C	Material-permitted temperature	igumid G/-40°C至+125°C
阻燃等级, igumid G	Flammability Class, igumid G	VDE 0304 IIC UL94 V2



ZQ28 拖链-产品规格范围 ZQ28 Cable Chain-Product specifications

ZQ28拖链-内外侧可开 ZQ28 Cable Chain-Inner and outer can be opened

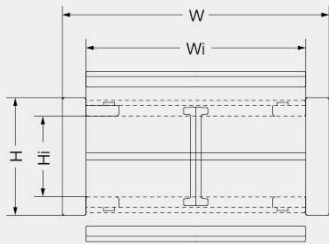

产品代码结构
Part Number Structure

ZQ2840*R*L*n

- 数量 (Quantity)
- 拖链长度 (Length of Cable chains)
- 弯曲半径 (Bending Radius)
- 内宽 (Inner Width)
- 型号 (Type)

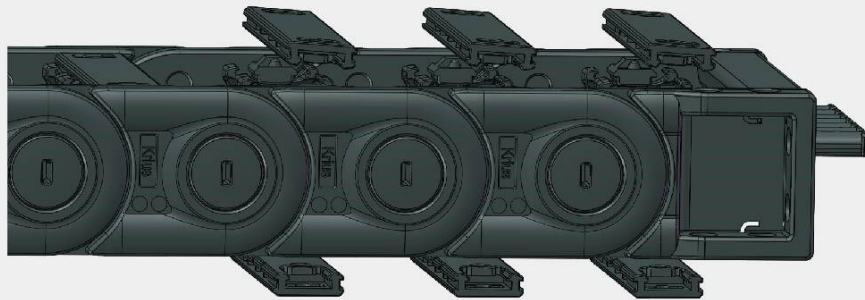

型号 Type	弯曲半径<R> Bending radius	内高<Hi> Inner height	内宽<Wi> Inner width	外高<H> Outer height	外宽<W> Outer Width	重量<G> Weight	备注 Remark
	mm (in.)	mm (in.)	mm (in.)	mm (in.)	mm (in.)	kg/m (lbs/ft)	
ZQ2840		28.2 (1.11)	41 (1.61)	43(1.69)	61 (2.40)	0.80 (0.54)	
ZQ2850			51 (2.01)		71 (2.80)	1.10 (0.75)	
ZQ2862			63 (2.48)		83 (3.27)	1.26 (0.86)	
ZQ2870			71 (2.80)		91 (3.58)	1.35 (0.92)	
ZQ2875			76 (2.99)		96 (3.78)	1.43 (0.97)	
ZQ2887			88 (3.46)		108 (4.25)	1.54 (1.05)	
ZQ28100			101 (3.98)		121 (4.76)	1.61 (1.09)	
ZQ28125			126 (4.96)		146 (5.75)	1.73 (1.18)	

订货范例
Order details

ZQ2840 * R125 * 1000mm * 2

R	H _L	D	K	P
55 (2.17)	153 (6.02)	120 (4.72)	265 (10.43)	46 (1.81)
63 (2.48)	169 (6.65)	136 (5.35)	290 (11.42)	46 (1.81)
75 (2.95)	193 (7.60)	160 (6.30)	330 (12.99)	46 (1.81)
100 (3.94)	243 (9.57)	210 (8.27)	405 (15.94)	46 (1.81)
125 (4.92)	293 (11.54)	260 (10.24)	485 (19.09)	46 (1.81)
150 (5.91)	343 (13.50)	310 (12.20)	565 (22.24)	46 (1.81)
175 (6.89)	393 (15.47)	360 (14.17)	640 (25.20)	46 (1.81)
200 (7.87)	443 (17.44)	410 (16.14)	720 (28.35)	46 (1.81)
250 (9.84)	543 (21.38)	510 (20.08)	880 (34.65)	46 (1.81)

ZQ28 拖链-拖链接头 ZQ28 Cable Chain-Mounting Bracket

塑料接头, 分体式 Plastic Mounting Bracket, Splitted structure

- 各个侧面均有安装孔
- 双侧独立式带梳状片接头
- 两端接头均可活动
- 耐腐蚀 & 耐摩擦
- 可提供预装配形式
- 可实现内外连接
- Mounting brackets with attachment points on each side
- Separate mounting bracket with tie wrap plate on both side
- Moved connectors on both sides
- Anti-corrosion, Rub-resistance
- Available preassembly form
- Can realize the internal and external connections

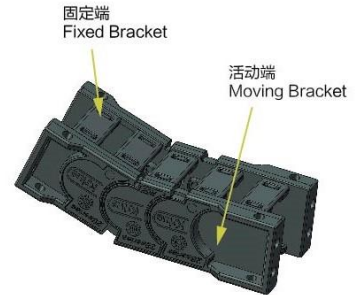

可选的接头安装方式 Available installation methods

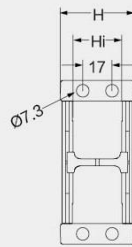
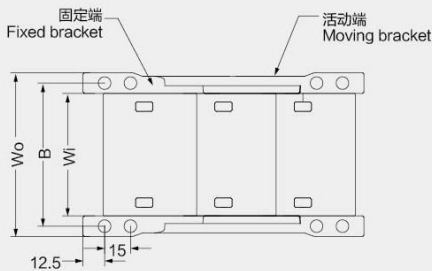
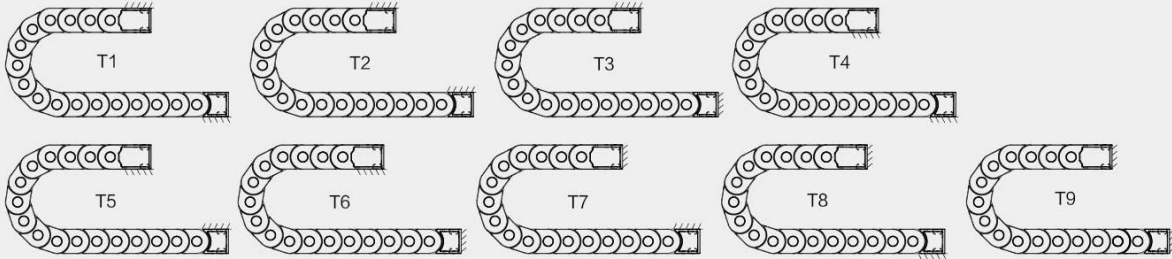

ZQ2840/ZQ2850
ZQ2862/ZQ2870
ZQ2875/ZQ2887
ZQ28100/ZQ28125

拖链型号 Type	拖链编码 Code	其他编码 Other Code		Wo尺寸 Dimension Wo	B尺寸 Dimension B
				mm (in.)	mm (in.)
ZQ2840	14210			65 (2.56)	53 (2.09)
ZQ2850	14211	接头 Mounting Bracket	14204 锁扣 14205 Fixed Button	75 (2.95)	63 (2.48)
ZQ2862	14212			87 (3.43)	75 (2.95)
ZQ2870	14213	主体 Main Body Code	14203 耐磨片 14228 Anti-friction part	95 (3.74)	83 (3.27)
ZQ2875	14214	隔离片 Separator	14208 梳状片 14227 Tie-wrap plate	100 (3.94)	88 (3.46)
ZQ2887	14215			112 (4.41)	100 (3.94)
ZQ28100	14216	弹片 Anti-noise part	14207	125 (4.92)	113 (4.45)
ZQ28125	14217			150 (5.91)	138 (5.43)

产品代码结构 Part Number Structure

ZQ2840*B*T1



- ZQ2840*B*T1*n 两端接头
On both brackets
- ZQ2840*f*T1*n 固定端接头
Fixed bracket
- ZQ2840*m*T1*n 移动端接头
Moving bracket

★ 每款拖链的接头都有所不同, 订购时如有任何疑问, 请及时咨询科瑞斯。
Every bracket is different, please contact us if you have any question.

ZQ28 拖链-隔离片 ZQ28 Cable Chain-Separator

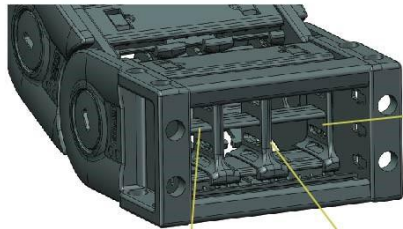

横隔片
Horizontal separator



两侧竖隔片
Vertical separator
on the two end

中间竖隔片
Vertical separator
in the middle part

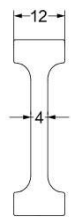
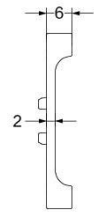
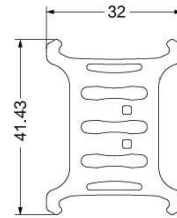

ZQ28拖链隔离片编码: 14208
The separator No. for ZQ28: 14208

- 本款拖链配备的隔离片为竖隔片和横隔片, 可以实现垂直和水平分隔
- 竖隔片和横隔片的数量可以根据客户的实际需求进行配备, 可以每隔一个链节装一个, 也可以每隔一个链节装几个, 客户可任意配备
- 竖隔片可以根据线缆的排布进行滑动
- Vertical and horizontal separator are available for different direction division
- Vertical and horizontal separators can be placed into each link or different quantity links, it can be customized
- Vertical separator can be moved for different cables

ZQ28 拖链-梳状板 ZQ28 Cable Chain-Tie-wrap plate

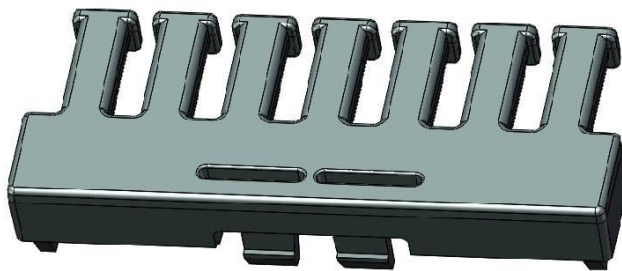

梳状板为独立部件, 可根据需要进行选配
Tie-wrap plate are independent parts, you can order or not referring to your demand

选配代码结构
Part Number Structure

ZQ2840+C型槽+梳状片
ZQ2840+C-Rail+Tie-wrap plate

内宽 (Inner Width)
型号 (Type)

单个梳状板
Single tie-wrap plate

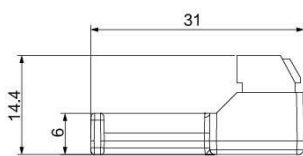

组装图
Shown assembled

