

## ZQ56 拖链-安装尺寸及技术参数 ZQ56 Cable Chain-Installation Dimensions and Technical Parameters

### 架空长度

#### Unsupported length

- $L_G$  = 直线架空长度
- $L_A$  = 安全塌腰架空长度
- $L_G$  = Unsupported with straight upper run
- $L_A$  = Unsupported with permitted sag

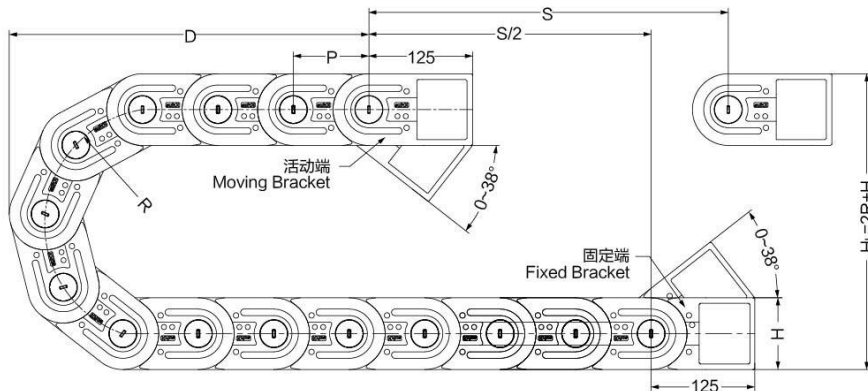
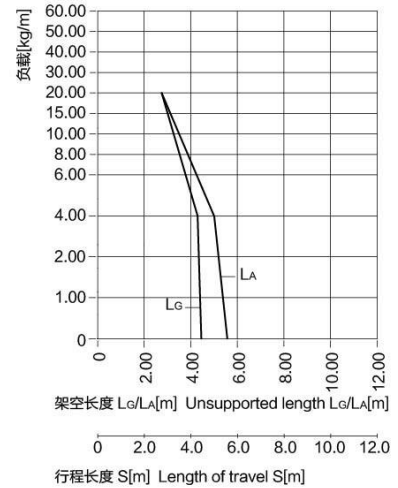
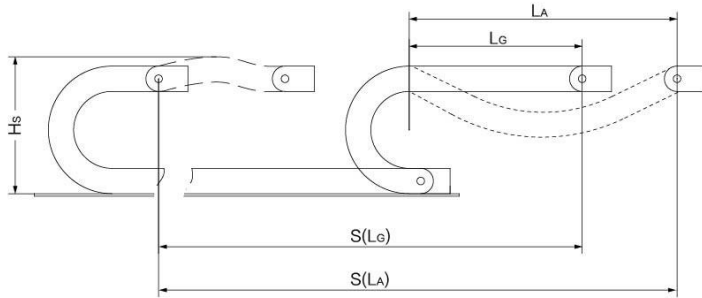

- S = 行程长度
- R = 弯曲半径
- P = 节距
- L = 拖链长度
- N = 每米链节数
- H<sub>L</sub> = 理论安装高度
- H<sub>s</sub> = 实际安装高度
- D = 拖链退回极限位置时的最小距离
- K =  $\pi \cdot R + 2P$
- \* K值可在科瑞斯相关表格中直接查询
- S = Length of travel
- R = Bending Radius
- P = Pitch
- L = Length of chain
- N = Links per meter
- H<sub>L</sub> = Nominal clearance height
- H<sub>s</sub> = Required clearance height
- D = Overlength Energy Chain radius in final position
- K =  $\pi \cdot R + 2P$
- \* You can find it from below chart for more details

| R           | H <sub>L</sub> | D            | K            | P         |
|-------------|----------------|--------------|--------------|-----------|
| 135 (5.31)  | 357 (14.06)    | 280 (11.02)  | 605 (23.82)  | 91 (3.58) |
| 150 (5.91)  | 387 (15.24)    | 310 (12.20)  | 655 (25.79)  | 91 (3.58) |
| 175 (6.89)  | 437 (17.20)    | 360 (14.17)  | 730 (28.74)  | 91 (3.58) |
| 200 (7.87)  | 487 (19.17)    | 410 (16.14)  | 810 (31.89)  | 91 (3.58) |
| 240 (9.45)  | 567 (22.32)    | 490 (19.29)  | 935 (36.81)  | 91 (3.58) |
| 250 (9.84)  | 587 (23.11)    | 510 (20.08)  | 965 (37.99)  | 91 (3.58) |
| 300 (11.81) | 687 (27.05)    | 610 (24.02)  | 1125 (44.29) | 91 (3.58) |
| 350 (13.78) | 787 (30.98)    | 710 (27.95)  | 1280 (50.39) | 91 (3.58) |
| 400 (15.75) | 887 (34.92)    | 810 (31.89)  | 1440 (56.69) | 91 (3.58) |
| 450 (17.72) | 987 (38.86)    | 910 (35.83)  | 1595 (62.80) | 91 (3.58) |
| 500 (19.69) | 1087 (42.80)   | 1010 (39.76) | 1750 (68.90) | 91 (3.58) |

实际安装高度:  $H_s = H_L + 85\text{mm}$   
拖链长度:  $L = S/2 + K$   
每米链节数:  $N = 11$  (1001mm)

The required clearance height:  $H_s = H_L + 3.75\text{in.}$   
Chain length:  $L = S/2 + K$   
Links per meter:  $N = 11$  (39.41in.)

| 技术参数 Technical Parameters |                                |  |
|---------------------------|--------------------------------|--|
| 速度/加速度 $L_G$              | Speed/acceleration $L_G$       | max.25[m/s]/max.205[m/s <sup>2</sup> ] |
| 速度/加速度 $L_A$              | Speed/acceleration $L_A$       | max.5[m/s]/max.8[m/s <sup>2</sup> ]    |
| 滑行速度/加速度                  | Gliding speed/acceleration     | max.5[m/s]/max.12[m/s <sup>2</sup> ]   |
| 材料-允许温度 °C                | Material-permitted temperature | igumid G/-40°C至+125°C                  |
| 阻燃等级, igumid G            | Flammability Class, igumid G   | VDE 0304 IIC UL94 V2                   |

## ZQ56 拖链-产品规格范围 ZQ56 Cable Chain-Product specifications

ZQ56拖链-内外侧可开 ZQ56 Cable Chain-Inner and outer can be opened

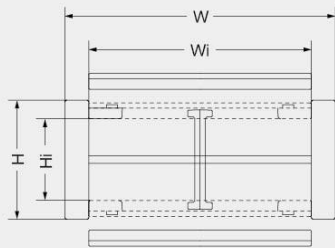

产品代码结构  
Part Number Structure

ZQ5675\*R\*L\*n

- 数量 (Quantity)
- 拖链长度 (Length of Cable chains)
- 弯曲半径 (Bending Radius)
- 内宽 (Inner Width)
- 型号 (Type)

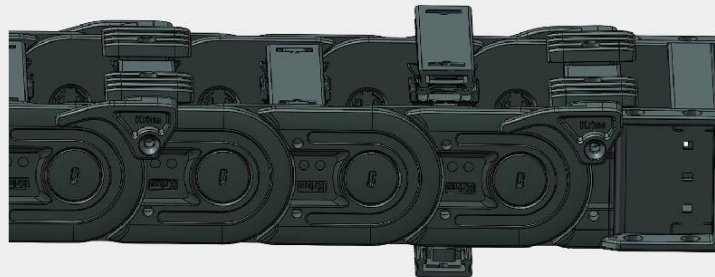

| 型号<br>Type | 弯曲半径<R><br>Bending radius | 内高<Hi><br>Inner height | 内宽<Wi><br>Inner width | 外高<H><br>Outer height | 外宽<W><br>Outer Width | 重量<G><br>Weight | 备注<br>Remark |
|------------|---------------------------|------------------------|-----------------------|-----------------------|----------------------|-----------------|--------------|
|            | mm (in.)                  | mm (in.)               | mm (in.)              | mm (in.)              | mm (in.)             | kg/m (lbs/ft)   |              |
| ZQ5675     |                           | 56 (2.20)              | 75 (2.95)             | 86.4 (3.40)           | 105 (4.13)           | 3.26 (2.22)     |              |
| ZQ56100    |                           |                        | 100 (3.94)            |                       | 130 (5.12)           | 3.39 (2.31)     |              |
| ZQ56125    |                           |                        | 125 (4.92)            |                       | 155 (6.10)           | 3.54 (2.41)     |              |
| ZQ56150    |                           |                        | 150 (5.91)            |                       | 180 (7.09)           | 3.69 (2.51)     |              |
| ZQ56175    |                           |                        | 175 (6.89)            |                       | 205 (8.07)           | 3.84 (2.61)     |              |
| ZQ56200    |                           |                        | 200 (7.87)            |                       | 230 (9.06)           | 3.96 (2.69)     |              |
| ZQ56250    |                           |                        | 250 (9.84)            |                       | 280 (11.02)          | 4.13 (2.81)     |              |
| ZQ56300    |                           |                        | 300 (11.81)           |                       | 330 (12.99)          | 4.31 (2.93)     |              |

订货范例  
Order details

ZQ5675 \* R135 \* 1000mm \* 2

| R           | Hl           | D            | K            | P         |
|-------------|--------------|--------------|--------------|-----------|
| 135 (5.31)  | 357 (14.06)  | 280 (11.02)  | 605 (23.82)  | 91 (3.58) |
| 150 (5.91)  | 387 (15.24)  | 310 (12.20)  | 655 (25.79)  | 91 (3.58) |
| 175 (6.89)  | 437 (17.20)  | 360 (14.17)  | 730 (28.74)  | 91 (3.58) |
| 200 (7.87)  | 487 (19.17)  | 410 (16.14)  | 810 (31.89)  | 91 (3.58) |
| 240 (9.45)  | 567 (22.32)  | 490 (19.29)  | 935 (36.81)  | 91 (3.58) |
| 250 (9.84)  | 587 (23.11)  | 510 (20.08)  | 965 (37.99)  | 91 (3.58) |
| 300 (11.81) | 687 (27.05)  | 610 (24.02)  | 1125 (44.29) | 91 (3.58) |
| 350 (13.78) | 787 (30.98)  | 710 (27.95)  | 1280 (50.39) | 91 (3.58) |
| 400 (15.75) | 887 (34.92)  | 810 (31.89)  | 1440 (56.69) | 91 (3.58) |
| 450 (17.72) | 987 (38.86)  | 910 (35.83)  | 1595 (62.80) | 91 (3.58) |
| 500 (19.69) | 1087 (42.80) | 1010 (39.76) | 1750 (68.90) | 91 (3.58) |

## ZQ56 拖链-拖链接头 ZQ56 Cable Chain-Mounting Bracket

塑料接头, 分体式 Plastic Mounting Bracket, Splitted structure

- 双侧独立式带梳状片接头
  - 两端接头均可活动
  - 耐腐蚀 & 耐摩擦
  - 可提供预装配形式
  - 可实现内外连接
- Separate mounting bracket with tie warp plate on both side
  - Moved connectors on both sides
  - Anti-corrosion, Rub-resistance
  - Available preassembly form
  - Can realize the internal and external connections

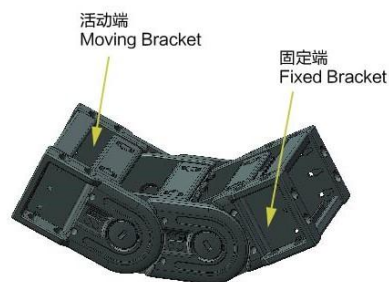

可选配的接头安装方式 Available installation methods

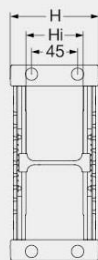
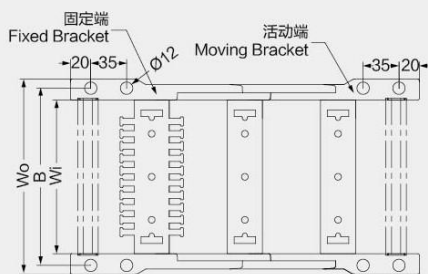
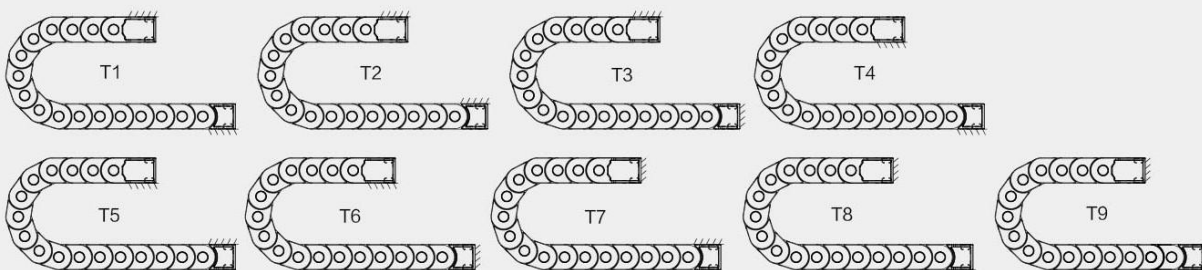

ZQ5675 / ZQ56100 / ZQ56125 / ZQ56150  
ZQ56175 / ZQ56200 / ZQ56250 / ZQ56300

| 拖链型号<br>Type | 拖链编码<br>Code | 其他编码<br>Other Code        |             | Wo尺寸<br>Dimension Wo | B尺寸<br>Dimension B |
|--------------|--------------|---------------------------|-------------|----------------------|--------------------|
|              |              |                           |             | mm (in.)             | mm (in.)           |
| ZQ5675       | 14275        |                           |             | 116 (4.57)           | 98 (3.86)          |
| ZQ56100      | 14276        |                           |             | 141 (5.55)           | 123 (4.84)         |
| ZQ56125      | 14277        | 接头<br>Mounting Bracket    | 14269 14270 | 166 (6.54)           | 148 (5.83)         |
| ZQ56150      | 14278        | 主体<br>Main Body Code      | 14268       | 191 (7.52)           | 173 (6.81)         |
| ZQ56175      | 14279        | 弹片<br>Anti-noise part     | 14272       | 216 (8.50)           | 198 (7.80)         |
| ZQ56200      | 14280        | 锁扣<br>Fixed Button        | 14271       | 241 (9.49)           | 223 (8.78)         |
| ZQ56250      | 14281        | 耐磨片<br>Anti-friction part | 14274       | 291(11.46)           | 273 (10.75)        |
| ZQ56300      | 14282        |                           |             | 341(13.43)           | 323 (12.72)        |

产品代码结构 Part Number Structure

### ZQ5675\*B\*T1



- ZQ5675\*B\*T1\*n 两端接头  
On both brackets
- ZQ5675\*f\*T1\*n 固定端接头  
Fixed bracket
- ZQ5675\*m\*T1\*n 移动端接头  
Moving bracket

★ 每款拖链的接头都有所不同, 订购时如有任何疑问, 请及时咨询科瑞斯。  
Every bracket is different, please contact us if you have any question.

### ZQ56 拖链-隔离片 ZQ56 Cable Chain-Separator

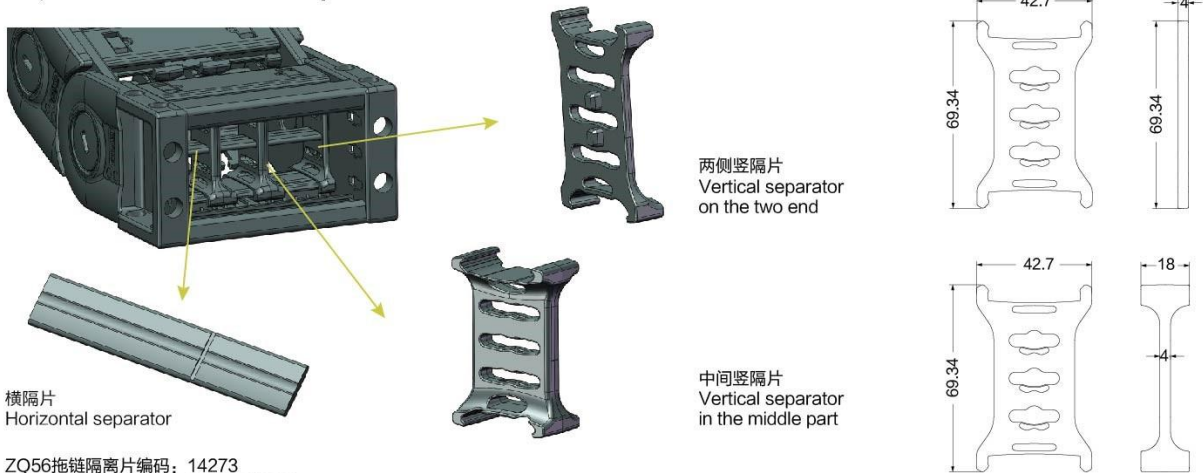

ZQ56拖链隔离片编码: 14273  
The separator No. for ZQ56: 14273

- 本款拖链配备的隔离片为竖隔片和横隔片, 可以实现垂直和水平分隔
- 竖隔片和横隔片的数量可以根据客户的实际需求进行配备, 可以每隔一个链节装一个, 也可以每隔一个链节装几个, 客户可任意配备
- 竖隔片可以根据线缆的排布进行滑动
- Vertical and horizontal separator are available for different direction division
- Vertical and horizontal can be placed into each link or different quantity links, it can be customized
- Vertical separator can be moved for different cables

### ZQ56 拖链-梳状板 ZQ56 Cable Chain-Tie-wrap plate



梳状板为独立部件, 可根据需要进行选配  
Tie-wrap plate are independent parts, you can order or not referring to your demand

选配代码结构  
Part Number Structure

ZQ5675+C型槽+梳状片  
ZQ5675+C-Rail+Tie-wrap plate

单个梳状板  
Single tie-wrap plate

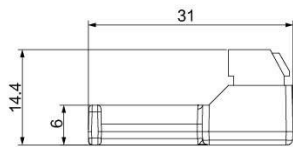

组装图  
Shown assembled

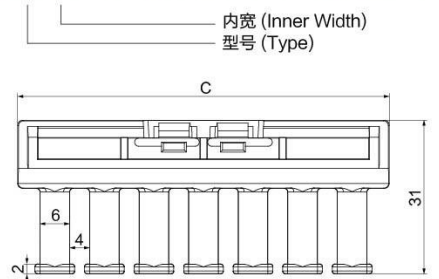
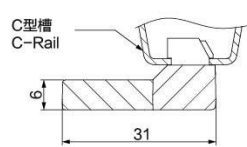

| 型号 Type | 齿数 Teeth NO. | 尺寸C Dimension C |
|---------|--------------|-----------------|
| ZQ5675  | 5            | 75 (2.95)       |
| ZQ56100 | 7            | 100 (3.94)      |
| ZQ56125 | 9            | 125 (4.92)      |
| ZQ56150 | 11           | 150 (5.91)      |
| ZQ56175 | 13           | 175 (6.89)      |
| ZQ56200 | 13           | 200 (7.87)      |
| ZQ56250 | 13           | 250 (9.84)      |
| ZQ56300 | 13           | 300 (11.81)     |